

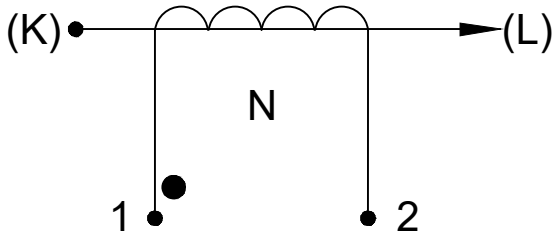

Product Type	PCB Mountable Current Transformer	
GT Part Number	L01-6505 to 6508	Index
Customer Part Number	-----	
Customer	SCHUKAT	
Place of Manufacture	GT Electronic India	

Page: 01 / 02

**SCHEMATIC:**



**ELECTRICAL SPECIFICATION:**

- ◆ Rated Input Current Range = 50A to 150A
- ◆ Operating Frequency = 50Hz / 60Hz
- ◆ Class 1 (5% to 120% of rated prim. current)
- ◆ Operating Temp. Range = -40°C to +120°C
- ◆ Rated Load Burden (Rb) = 33Ω
- ◆ Prim. to Sec. Isolation = 4kV / 50Hz / 2Sec

GT Part No.	Rated Current ( $I_{pri}$ )	Winding Resistance ( $RDC_{sec}$ )	Vout @rated current in Volt
L01-6505	50A	154Ω	0.66V
L01-6506	75A	213Ω	0.99V
L01-6507	100A	155Ω	1.32V
L01-6508	150A	133Ω	1V

**MECHANICAL SPECIFICATION:**

Bottom / Pin Side View:

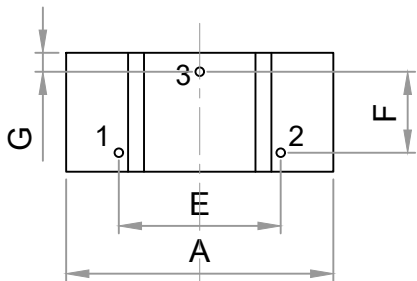

Front View:

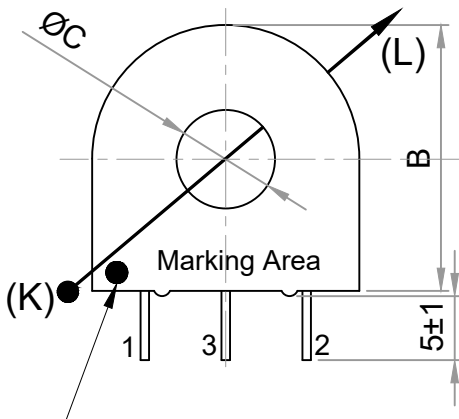

Start pin reference

Note : Pin#3 → Un-Used Pin

**MECHANICAL SPECIFICATION:**

GT Part No.	A	B	ØC	D	E	F	G	ØH
L01-6505	23.80	23.80	9.50	11.20	15.24	7.62	1.75	0.80
L01-6506	30.20	30.20	11.40	14.30	20.32	10.16	2.08	1.00
L01-6507	34.90	34.90	14.60	14.30	25.40	10.16	2.08	1.00
L01-6508	38.10	38.10	14.60	15.90	33.00	10.16	2.85	1.00

Side View:

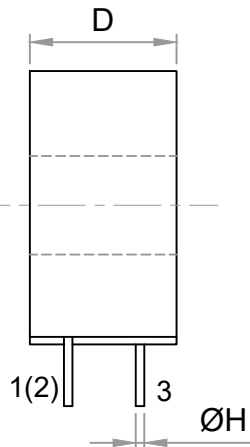

Marking Information	weight	SPQ
L01-6505 GT YY/WK	14 g/pc	234 pcs
L01-6506 GT YY/WK	45 g/pc	
L01-6507 GT YY/WK	67 g/pc	112 pcs
L01-6508 GT YY/WK	70 g/pc	45 pcs

All Dimensions are in mm  
Linear Dimensional Tolerance ±0.2mm

Product Type	PCB Mountable Current Transformer	
GT Part Number	L01-6505 to 6508	Index
Customer Part Number	-----	
Customer	SCHUKAT	
Place of Manufacture	GT Electronic India	



OUTPUT RESPONSE vs INPUT CURRENT @ RATED BURDEN:

L01-6505

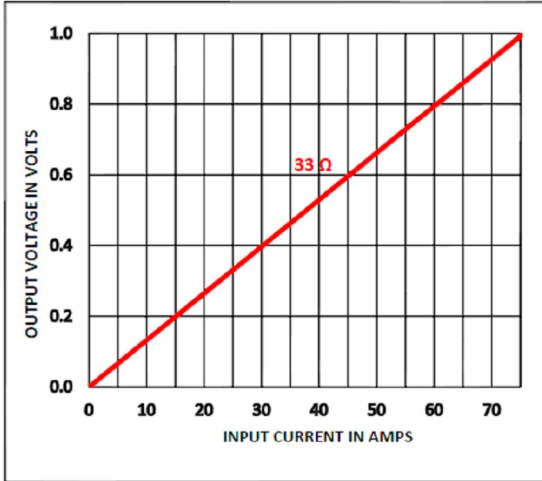

L01-6506

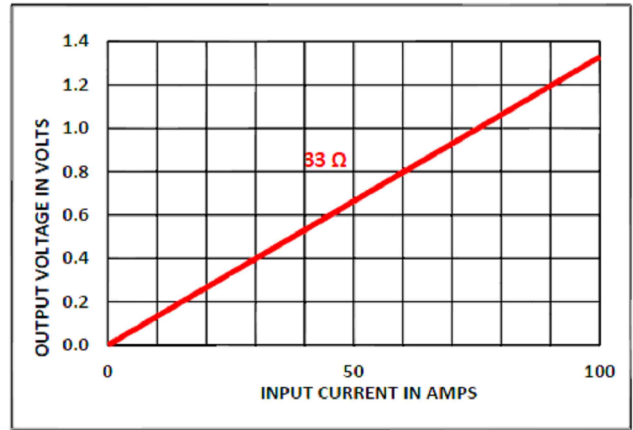

L01-6507

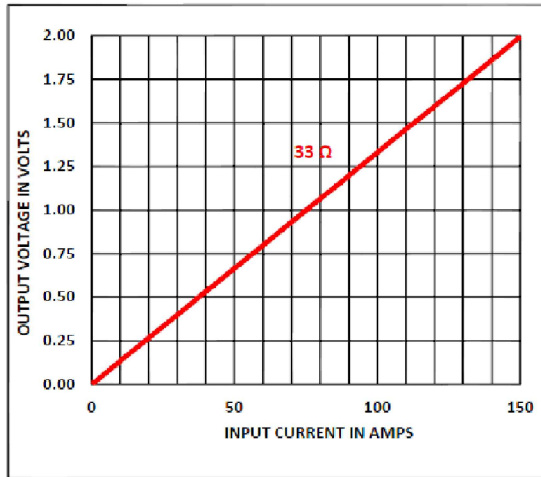

L01-6508

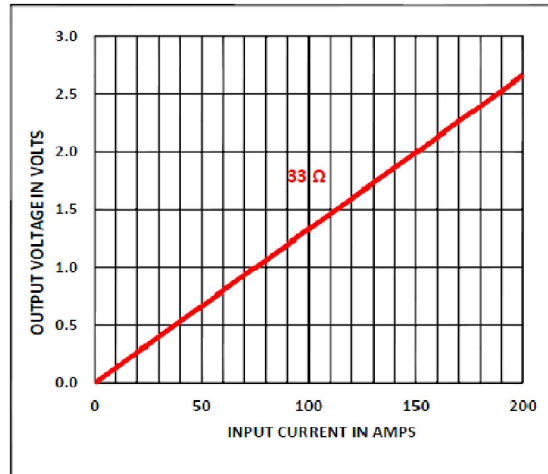

This product may contain harmful substances, it may require proper disposal subject to statutory & regulatory laws defined by the local governance of its own country/region as applicable at the time of disposal.

Date:	Approval of Customer:
-------	-----------------------

-----Initial Issue-----	1	0	D.Kirubakaran	26-09-2024
Changes	Issue	Rev	Prepared	Reviewed Date